



T2 TIMER (Single Shot)

T2K-AVGTMR-xxx

Timer Features:

- Microcontroller based timing
- Remaining/Elapsed Time Display
- Optional Password protection for unit/range
- Set time range from 0.01 sec to 999 hours
- Digital setting with 1% resolution, 1% Absolute Accuracy, and 1% Repeat Accuracy

Timer Function:

Input power must be applied before and during timing. Being positive edge-triggered, the Relay (R) energizes (contacts transfer) upon momentary or maintained closure of the switch (S1). The energized Relay triggers the time delay (SP). When the timer delay finishes countdown, the Relay de-energizes.

Note: Time delay is unaffected if switch is opened or closed during countdown. Timer is reset and restarted the next time the switch is closed. Losing power resets the time delay and de-energizes the output.

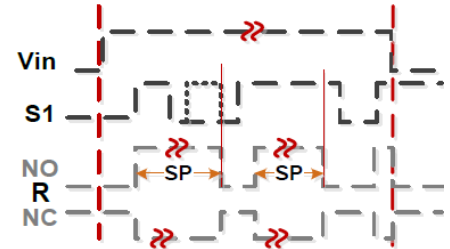

TECHNICAL DATA

TIME DELAY

Range: Depends on the Time Unit

S_{EC} 0.01 - 9.99 seconds

SEC 1-999 seconds

min 1-999 minutes

Hr 1-999 hours

Repeat Accuracy: +/-1% or 20 ms, whichever is greater

Reset Time: 5 ms max. (2 ms typical)

ENVIRONMENTAL

Storage Temperature: -50°C to 150°C

Operating Temperature: -20°C to 60°C

INPUT

Operating Voltage:

120, 240 VAC; 12, 24 VDC ±10%
(Unfiltered input voltage to DC Models must be full-wave rectified)

Power Consumption: 3 VA max.

Frequency: 50/60 Hz

PROTECTION

Dielectric Breakdown: 2000 VAC, RMS min. at 60 Hz between input and outputs and 1000VAC between outputs

Polarity: DC units are reverse polarity protected

OUTPUT

Type: Relay contacts

General Form:

DPDT (Double Pole Double Throw), 2 form C

Note: Model T2K-AVGTMR-441 supports

SPDT (Single Pole Double Throw)

Rating: 7A max. Resistive at 250 VAC;

100 mA at 5 VDC min. load current

Life (Number of Operations):

Mechanical: 1 x 10⁷

Electrical: 1 x 10⁵

MECHANICAL DATA – WIRING AND DIMENSIONS

Termination: 8-pin or 11-pin plug (depending on model)

Mounting type: Socket Mount

Dimensions: 1.790 x 2.887 x 2.412 in.

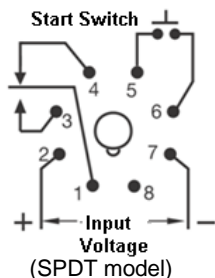

8-PIN CONFIGURATION

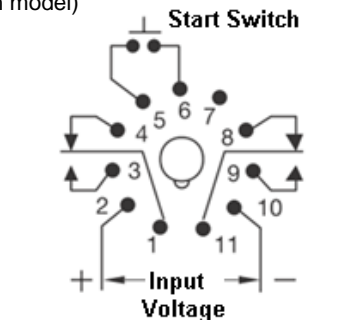

(Polarity is shown for DC models)

11-PIN CONFIGURATION

Unit: inch [mm]

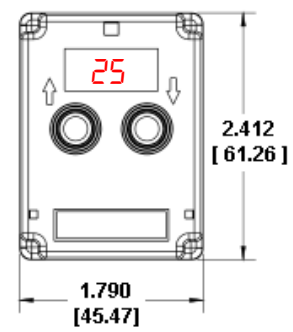

FRONT VIEW

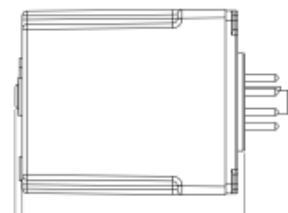

SIDE VIEW

HOW TO ORDER

Timers:

12 VDC, 11 pin (DPDT Relay Out)

24 VDC, 11 pin (DPDT Relay Out)

120 VAC, 11 pin (DPDT Relay Out)

120 VAC, 8 pin (SPDT Relay Out)

240 VAC, 11 pin (DPDT Relay Out)

T2K-AVGTMR-466

T2K-AVGTMR-462

T2K-AVGTMR-461

T2K-AVGTMR-441

T2K-AVGTMR-465

Socket: All models require either an 8-pin or 11-pin socket listed below:

8 Pin Socket:

11 Pin Socket:

AVG-TMRSKT-8PIN

AVG-TMRSKT-11PIN





T2 TIMER (Single Shot)

T2K-AVGTMR-xxx

Operation and Programming

Timer has two buttons and a 3 digit display for programming. The following button actions are used in programming:

- Pressing Left (L) or ↑ button increments a value or moves from one parameter to another.
- Pressing Right (R) or ↓ button decrements a value or selects a parameter to edit.
- Pressing Both Left and Right (LR) button saves the displayed value and/or advances timer to next parameter.
- Pressing Left (L) or Right (R) from the default display will prompt timer to scroll through programmed values.

View Programmed Values:

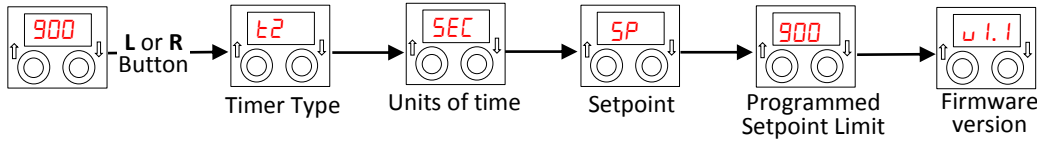

Adjust Setpoint:

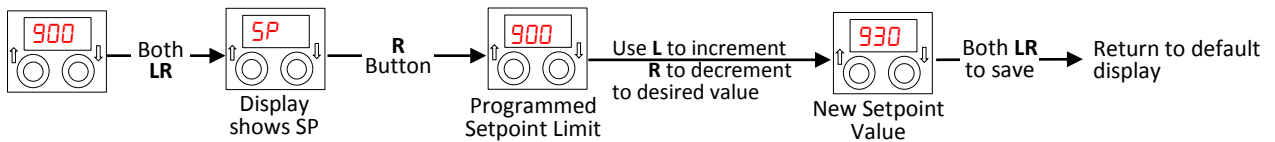

Programming Mode:

