



Multi-Function Timer

TM10-AVGTMR-xxx

Timer Features:

- Microcontroller based timing
- Remaining/Elapsed Time Display
- Optional Password protection for unit/range and timer type
- Set time range from 0.01 sec to 999 hours
- Digital setting with 1% resolution, 1% Absolute Accuracy, and 1% Repeat Accuracy

10 Programmable Timer Types:

- T1 (Delay On Make)
- T2 (Single Shot)
- T3 (Delay On Break)
- Cycle
- Interval
- Re-triggerable Single Shot
- Inverted Single Shot
- Trailing Single Shot
- Inverted Delay On Break
- Accumulated Delay On Make



TECHNICAL DATA

TIME DELAY

Range: Depends on the Time Unit

- S_EC* 0.01 - 9.99 seconds
- SEC* 1-999 seconds
- min* 1-999 minutes
- Hr* 1-999 hours

Repeat Accuracy: +/-1% or 20 ms, whichever is greater

Reset Time: 5 ms max. (2 ms typical)

ENVIRONMENTAL

Storage Temperature: -50°C to 150°C

Operating Temperature: -20°C to 60°C

INPUT

Operating Voltage:

120, 240 VAC; 12, 24 VDC ±10%
(Unfiltered input voltage to DC Models must be full-wave rectified)

Power Consumption: 3 VA max.

Frequency: 50/60 Hz

PROTECTION

Dielectric Breakdown: 2000 VAC, RMS min. at 60 Hz between input and outputs and 1000VAC between outputs

Polarity: DC units are reverse polarity protected

OUTPUT

Type: Relay contacts

Form: DPDT (Double Pole Double Throw), 2 form C

Rating: 7A max. Resistive at 250 VAC; 100 mA at 5 VDC min. load current

Life (Number of Operations):

Mechanical: 1 x 10⁷
Electrical: 1 x 10⁵

MECHANICAL DATA – WIRING AND DIMENSIONS

Termination: 11-pin plug

Mounting type: Socket Mount

Dimensions: 1.790 x 2.887 x 2.412 in.

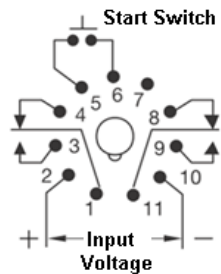

11-PIN CONFIGURATION

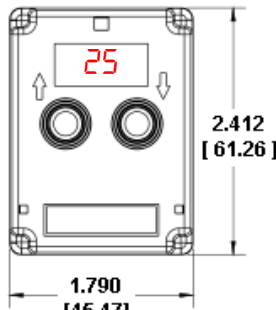

FRONT VIEW

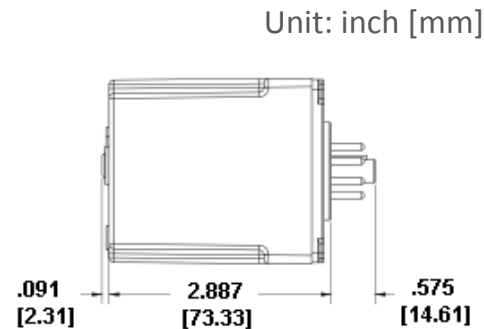

SIDE VIEW

Unit: inch [mm]

HOW TO ORDER

Multi-Function Timers

12 VDC Input:

TM10-AVGTMR-466

24 VDC Input:

TM10-AVGTMR-462

120 VAC Input:

TM10-AVGTMR-461

240 VAC Input:

TM10-AVGTMR-465



Socket: All models require an 11-pin socket listed below:

11 Pin Socket:

AVG-TMRSKT-11PIN



The 10 different Modes available in this Timer unit are as follows:

Delay On Make Timer (t1)

When input power is applied, the timer delay (SP) begins. At the end of the set time delay, the Relay (R) energizes (contacts transfer) and remains energized as long as input power is supplied. The timer and relay are reset on loss of power.

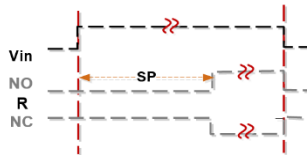

Single Shot Timer (t2)

Input Power (V) must be applied to the timer before and during timing. Being Positive edge-triggered, the Relay (R) energizes (contacts transfer) upon momentary or maintained closure of the switch (S1). The energized Relay triggers the time delay (SP). When the timer delay finishes counting down, the Relay de-energizes.

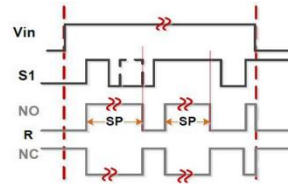

Note: The time-delay remains unaffected if the switch is opened or closed during the timing countdown. The Timer is reset and re-started the next time the Switch (S1) is closed. Losing power resets the time delay and de-energizes the output.

Delay On Break Timer (t3)

Input Power (V) must be applied to the timer before and during timing. When the switch (S1) is closed, the Relay (R) is energized (contacts transfer). The time delay (SP) begins when the switch is opened (negative edge-triggered) and the output remains energized during timing. The Relay de-energizes at the end of the time delay. Closing the switch while timing will reset the time delay while the relay remains energized.

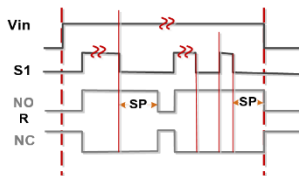

Cycle Timer (t4)

When input power is applied, the Relay output is energized and the TON timer begins counting down from the set TON time. At the end of the TON time, the output de-energizes and the TOF time begins its countdown. At the end of the TOF time, the output is energized and the cycle repeats as long as power is applied.

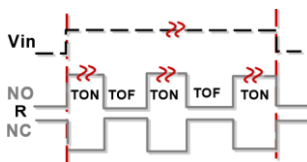

Interval Timer (t5)

This mode of operation indicates that the timer delay (SP) begins (and the Relay output is energized) as soon as the input power at operating voltage (V) is supplied. At the end of time delay, the output is de-energized and remains de-energized until power is removed.

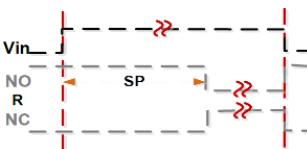

Retriggerable Single Shot Timer (t55)

Input Power (V) must be applied to the timer before and during timing. Upon momentary or maintained closure of the initiate switch (Positive edge-triggered), the Relay output is energized for a measured interval of time (SP). When the timer finishes timing, the Relay de-energizes.

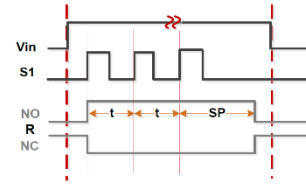

Note: Unlike the Single-shot timer, the time-delay is immediately Reset if the switch is closed while timing.

Trailing Single Shot (t55)

Input Power (V) must be applied to the timer before and during timing. Although the timer remains unaffected when the Switch is initially closed, the Relay (R) output is energized as soon as the switch is opened (Trailing edge-triggered), also triggering the time delay (SP). When the timer finishes timing, the Relay de-energizes. The timing remains unaffected if the switch is opened or closed during the timing. The Timer is reset and re-started the next time the Switch (S1) is opened.

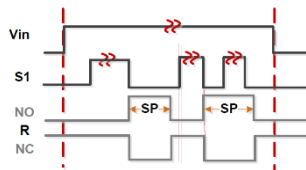

Inverted Single shot (t55)

Input Power (V) must be applied to the timer before and during timing. On startup, the Relay output is automatically energized. The Relay (R) output is de-energized upon momentary or maintained closure of the switch (S1). The Relay remains de-energized for a measured time-delay. When the timer finishes timing, the Relay re-energizes.

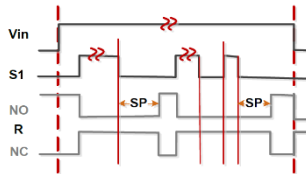

Note: The time-delay remains unaffected if the switch is opened or closed while timing. The Timer is reset and re-started the next time the Switch (S1) is closed.

Inverted Delay On Break (t55)

When the switch (S1) is closed, the Relay (R) output is de-energized. The time delay begins when the switch is opened (Negative edge triggered) and the output remains de-energized during timing. The output is energized at the end of the time delay.

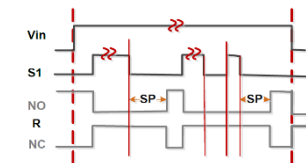

Note: Closing the switch while timing resets the time delay, but the output remains de-energized.

Accumulative Delay On Make (AdL)

This type of operation indicates that the timer delay begins timing upon momentary or maintained closure of the switch (S1). The timing is paused whenever the switch is opened. If S1 is re-opened, timing continues to accumulate. When the total accumulated elapsed time equals the selected time delay (SP), the Relay (R) output is energized and it remains so as long as input power is supplied. $SP = t_1 + t_2 + t_3 + \dots$

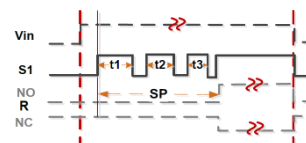



Multi-Function Timer

TM10-AVG TMR-xxx

Operation and Programming (Non-Cycle)

Timer has two buttons and a 3 digit display for programming. Following button actions are used in programming:

- Pressing Left (L) or ↑ button increments or moves from one parameter to another
- Pressing Right (R) or ↓ button decrements a value or selects a parameter to edit
- Pressing Both Left and Right (LR) button saves the displayed value and/or advances timer to next parameter.
- Pressing Left (L) or Right (R) from the default display will prompt timer to scroll through programmed values.

View Programmed Values:

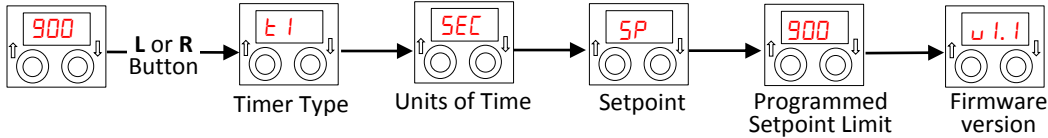

Adjust Setpoint:

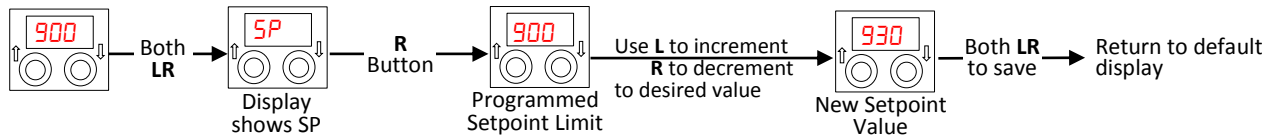

Programming Mode:

